

O talento para engenharia  
sempre esteve em você.

Na Facens você pode  
tirar seus projetos do  
papel e fazê-los decolar.

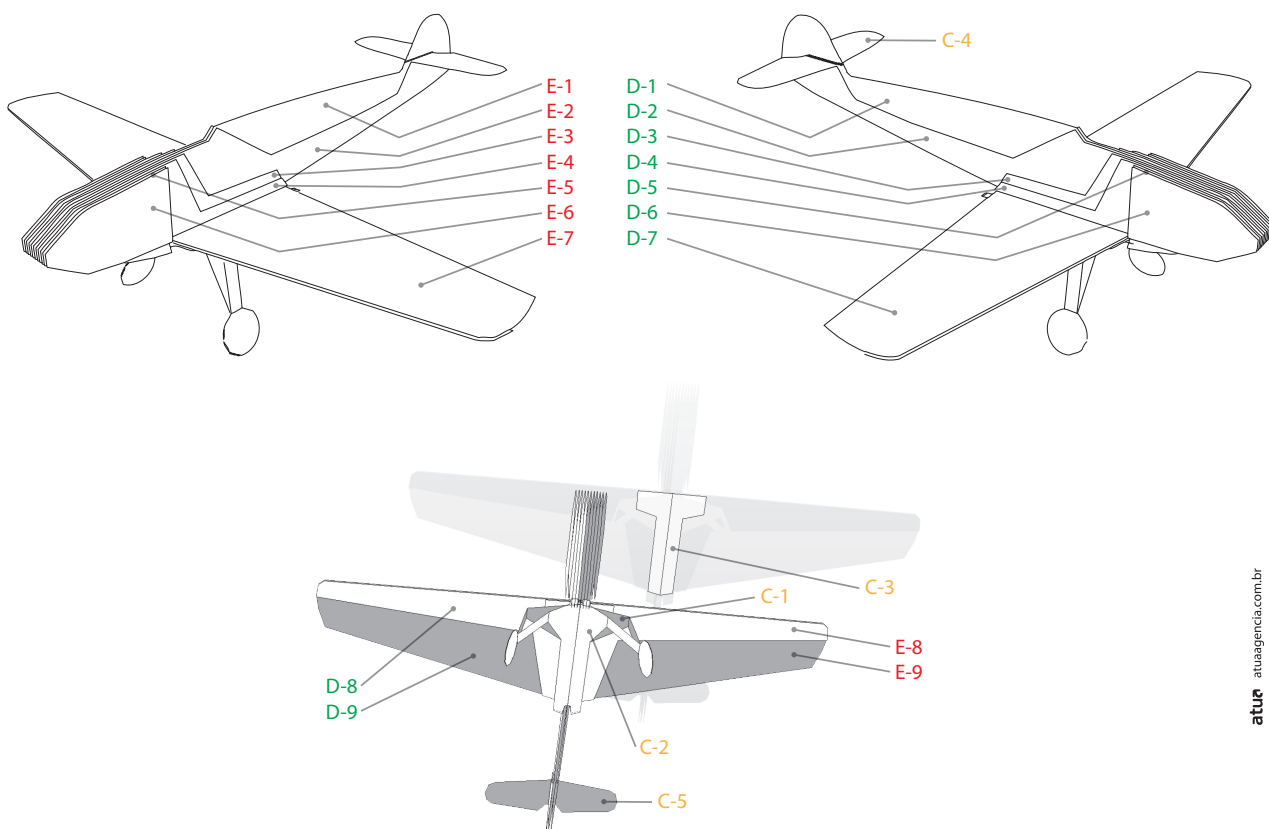

Instruções de Montagem do **Messerschmitt Bf 109**: Cole sobre E-1, sucessivamente, as partes E-2, E-3, E-4, E-5 e E-6. Cole D-1 na face oposta de E-1 e repita a operação para D-2, D-3, D-4, D-5 e D-6. Cole as asas (E-7 e D-7) nas abas das partes E-4 e D-4. Cole as faces inferiores das asas (E-8 e E-9, D-8 e D-9) e arremate com a peça C-3. Certifique-se de puxar as asas para cima, deixando-as levemente inclinadas antes da fixação de C-3. Cole C-1 em C-2 para o trem de pouso e fixe-o no corpo do avião. Para o profundor, cole C-4 em C-5 e insira no rasgo do leme. Cole-o nas abas de E-2 e D-2. Boa diversão!

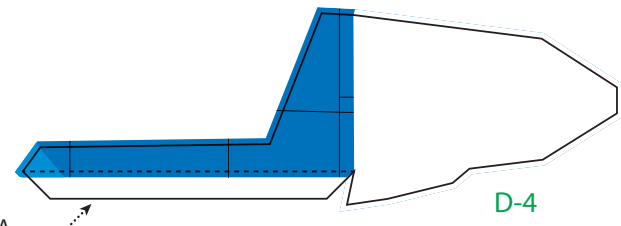
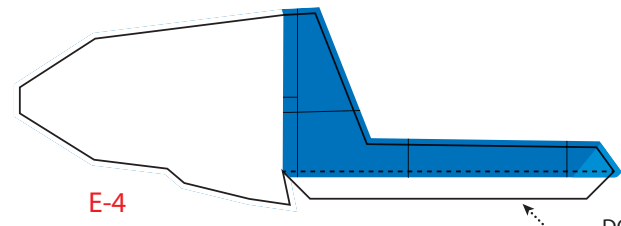
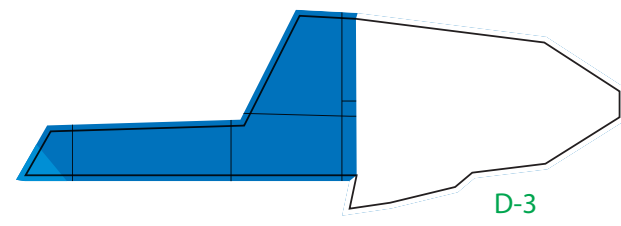
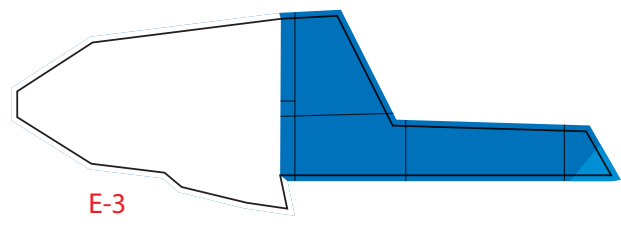
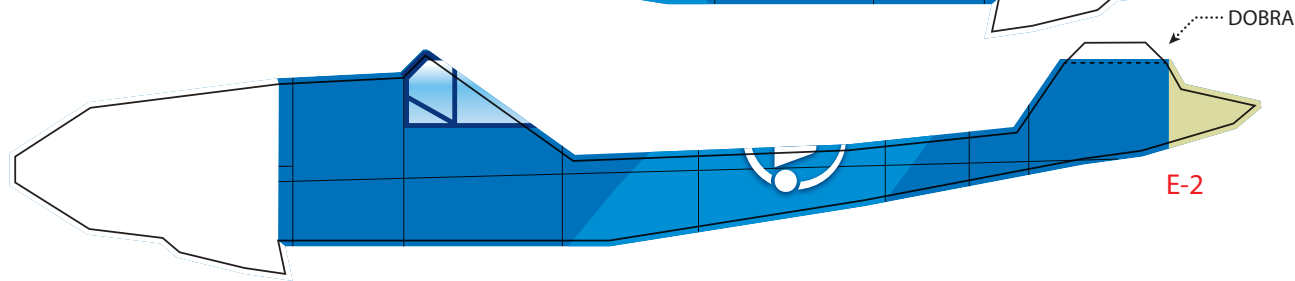
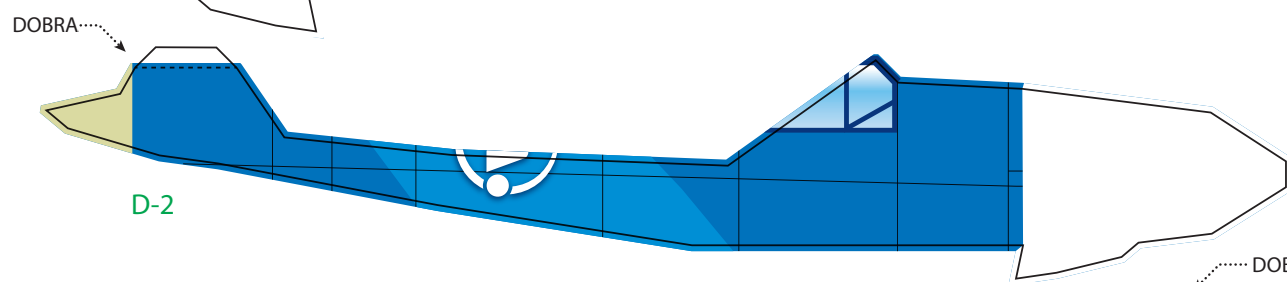
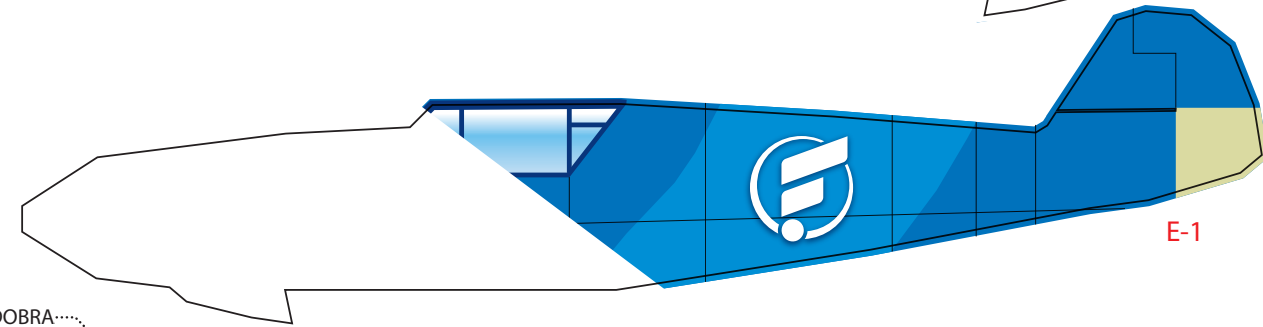
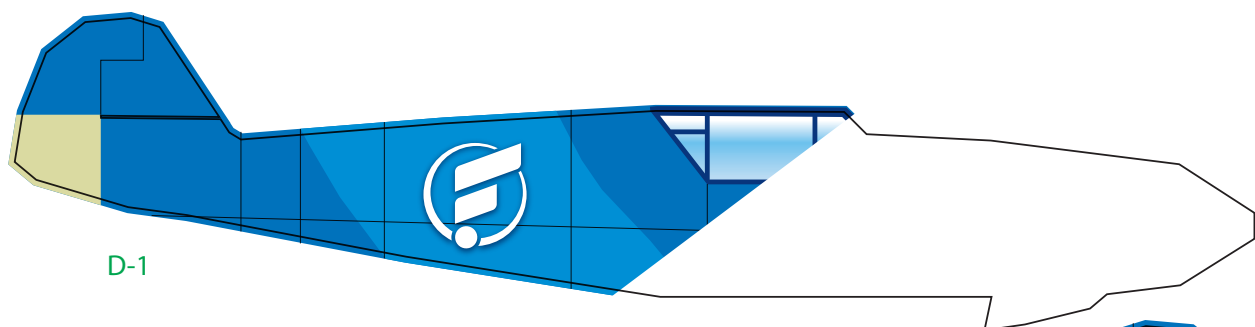

DOBRA.....

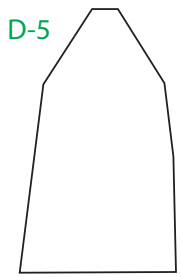

E-5

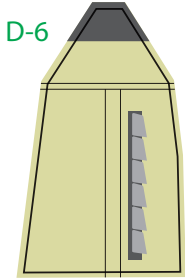

E-6

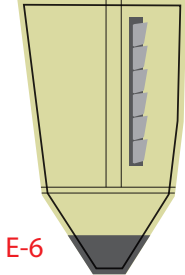
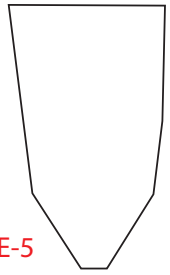

C-1

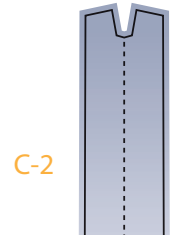

C-2

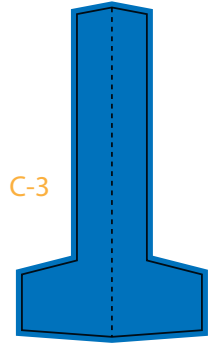

C-3

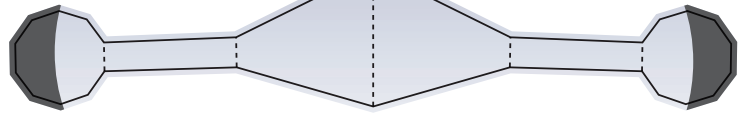

E-7

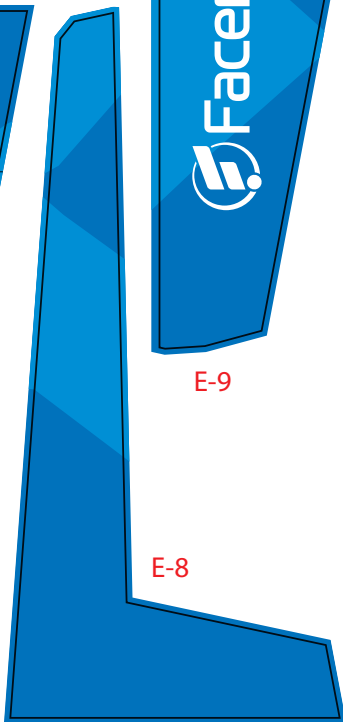

E-8



E-9



D-7



D-8



D-9

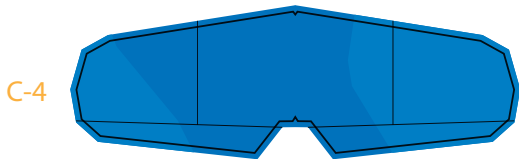

C-4

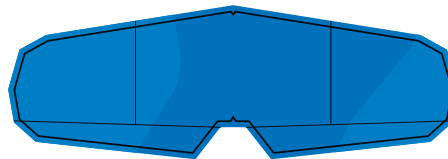

C-5